

INSTALLATION INSTRUCTION

Item NO.:E24274-20PC

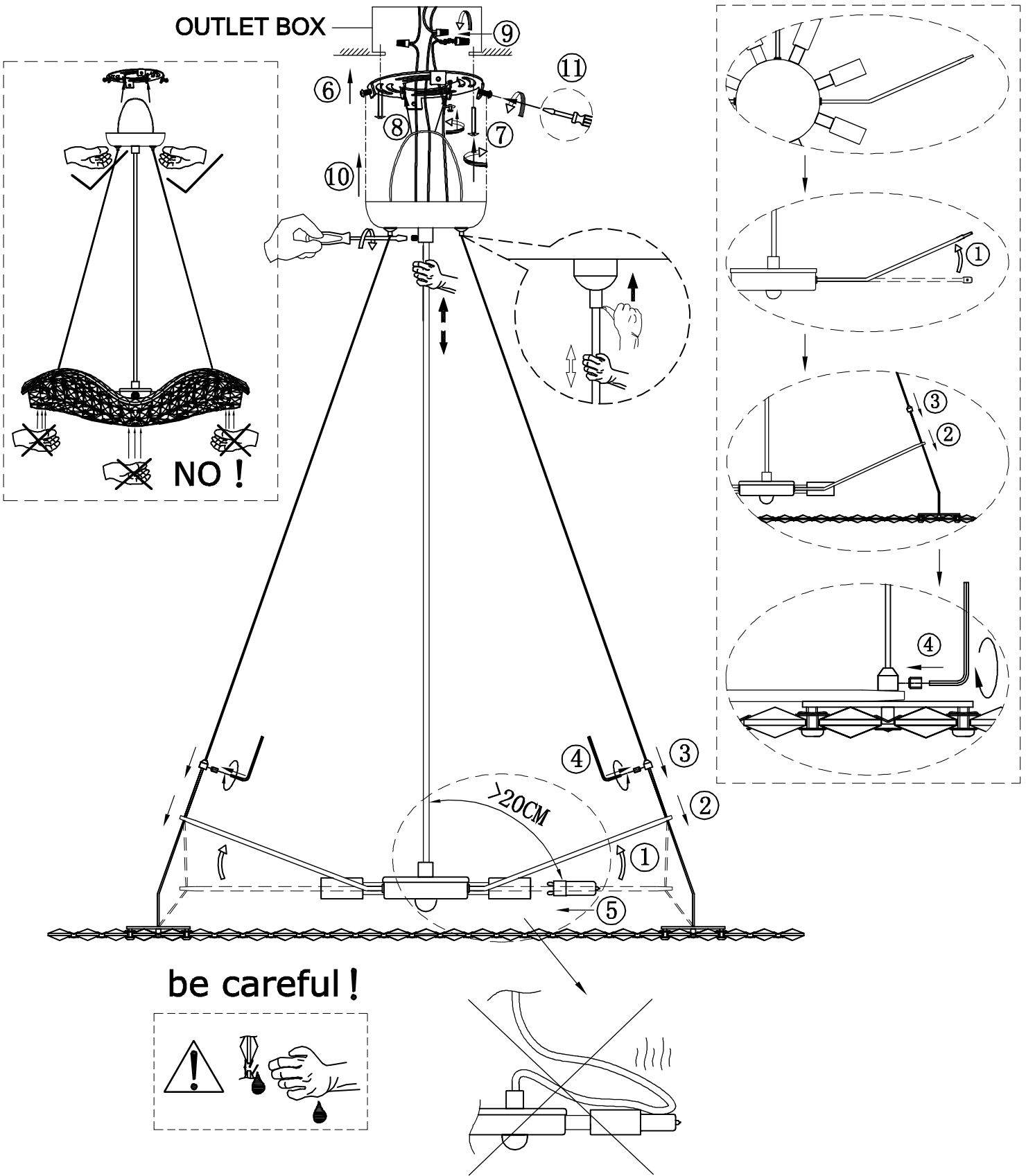

FEATURE

- Lamp Type: "Xenon" G9 8×MAX 60W 120V~60HZ
- The lamp is for indoor use only